



TECHNICAL SERVICE BULLETIN

REF.: BODY
NO.: BO94-006
DATE: APRIL 22, 1994
MODEL: ALL MODELS

SEAT BELT EXTENDER (1985 TO 1994 MODEL YEARS)

Page 1 of 10

A special program is available for individuals who require extra length seat belts. Owners of 1985 through 1994 vehicles can now obtain seat belt extenders at no cost through their local Toyota dealer. (On vehicles prior to 1985 – contact TMS-CR for availability.)

The extender is available in black only and in lengths of 6", 9", 12", 15" and 18".

Owners are informed of the seat belt extender availability through the Toyota Owner's Manual included in each 1987 or later vehicle (see page 9 for text of Owners Manual).

The owner must visit a Toyota Dealership to have the required measurements made and complete the application form. The completed application form will be forwarded to the TMS Customer Relations Department for processing (additional application forms are available at no cost by ordering the following part number through the Dealer Support Material Network MDC NPM system, **P/N 00403-00001-3M** QTY 1 = 5 forms).

To ensure timely delivery of the extender to the owner, the application **must be filled out completely and signed by the applicant.**

Attached are the following 1994 model year updated guides and examples:

- Flow Chart (Page 2)
- Seat Belt Extender Application/Part Number Chart (Pages 3 – 7)
- Owner Instruction Sheet (Page 8)
- Statement included in Owner's Manual (Page 9)
- Sample of completed form (Page 10)

The appropriate seat belt extender will be forwarded to the dealership parts department at no charge in about two weeks from receipt of the form. The dealership service department should complete the affixed Seat Belt Extender Label and review the "owner instruction sheet" with the owner.

To assure utmost owner satisfaction, it is recommended that a dealer designate one person to coordinate all activities related to the seat belt extender issue.

FLOW CHART

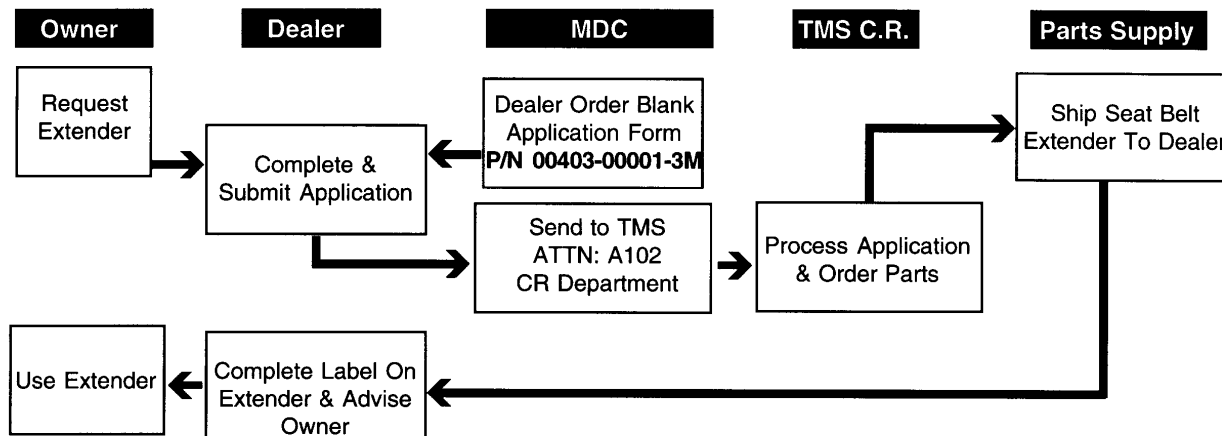

SEAT BELT LABEL

CAUTION	
THIS SEAT BELT EXTENDER IS TO BE USED ONLY BY: _____	
ON VEHICLE: _____	Customer Name
VIN: _____	
SEATING POSITION: _____	
Driver	Passenger
Front	Rear
USE BY OTHERS, OR IN ANOTHER SEATING POSITION, OR IN ANOTHER VEHICLE COULD REDUCE SEAT BELT RESTRAINT IN AN ACCIDENT AND RESULT IN PERSONAL INJURY.	

1. Owner request to dealer.
2. Dealer verifies need for extender and provides “application for seat belt extender” to owner. Dealer processes application form and sends it to TMS Customer Relations Department – A102.
 - Dealer retains copies 3 & 4 to process delivery to customer.
3. TMS Customer Relations Department records application form, copies 1 & 2.
 - Retain files in computer and microfilm.
 - Determines appropriate extender length for customer
 - Informs TMS Parts Department to ship parts to dealer.
4. Dealer records appropriate information on the label attached to the belt extender and contacts owner.
5. Dealer gives extender to owner. To determine the proper part number, locate the model, type and “series” on the following charts then refer to the part number chart on page 7 to find the appropriate part number for the “series” and length.

FRONT SEAT – EXTENDER APPLICATION TABLE

MODEL	TYPE	'94	'93	'92	'91	'90	'89	'88	'87	'86	'85
Cressida	USA Spec.			R-2*1	R-2*1	R-2*1	R-2*1	R-2	R-2	R-1	R-1
	Canada Spec.			K-3	K-3	K-3	K-3	K-1	K-1	K-1	K-1
Supra		R-3	R-3	R-1	R-1	R-1	R-1	R-1	R-1	R-1	R-1
Celica	L/B & Coupe	N-3	N-3	N-3	N-3	N-3	N-1	N-1	N-1	N-1	N-1
	Convertible		R-3	R-3	R-3	R-1	R-1	R-1	R-1	R-1	R-1
Camry	USA Spec.				R-2*1	R-2*1	R-2*1	R-2	R-2	K-1	K-1
	Canada Spec.				K-1	K-1	K-1	K-1	K-1	K-1	
	TMC	R-3	R-3	R-3							
	TMM	Q-2	Q-2	Q-2							
Corolla (2 dr)	Sedan & H/T										
	Coupe				R-2*1	R-2*1	R-1	R-1	R-1	R-1	R-1
	Liftback								R-1	R-1	R-1
	FX							R-1	R-1		
Corolla (4 dr)	Sedan	R-3*2	R-3	R-2*1	R-2*1	R-2*1	R-1	R-1	R-1	R-1	R-1
	Wagon	R-3*2	R-3	R-2*1	R-2*1	R-2*1	R-1	R-1			
	4WD Sedan			R-2*1	R-2*1	R-2*1	R-1				
	4WD Wagon		R-2	R-2*1	R-2*1	R-2*1	R-1	R-1			
	TMMC Prod.	Q-2*3	Q-2	R-2*1	R-2*1	R-2*1	R-1				
	NUMMI Prod.	Q-2*3	Q-2	R-2	R-2*1	R-2*1	R-1				
Tercel R-1	2,3 & 5 dr Sedan					R-2	R-1	R-2	R-2	R-1	R-1
	2 & 4 dr Sdn	RH	R-3*1	R-3*1	R-3*1	R-3*1					
		LH	R-3	R-3	R-3	R-3*1					
Wagon							R-1	R-1	R-1	R-1	
Paseo	RH	R-3*1	R-3*1	R-3*1							
	LH	R-3	R-3	R-3*1							
Starlet											
MR2		R-3	R-3	R-3	R-3	R-1	R-1	R-2	R-2	R-1	R-1
Truck *4 (TMC Prod.)	Regular Cab (TMC)	R-1	R-1	R-1	R-1	R-1	R-1	R-2	R-2	R-1	R-1
	Xtracab – (TMC)	R-1	R-1	R-1	R-1	R-1	R-1				
Truck *4 (Nummi Prod.)	Regular Cab (NUMMI)	Q-1	Q-1								
	Xtracab – (NUMMI)	R-1	R-1								

FRONT SEAT – EXTENDER APPLICATION TABLE CONT'D

MODEL	TYPE	'94	'93	'92	'91	'90	'89	'88	'87	'86	'85
T 100 *4		R-1	R-1								
4 Runner	2-dr		R-1	R-1	R-1	R-1	R-1	R-2	R-2	R-1	R-1
	4-dr	K-1	K-1	K-1	R-1	R-1	R-1				
Van/Previa		R-3	R-3	R-3	R-3	R-1	R-1	R-2	R-2	R-1	R-1
Land Cruiser	FJ60, FJ80	R-3	R-3	R-3	R-3	R-1*5	R-1	R-1	R-1	R-1	R-1
	FJ40, FJ70								K-1	K-1	K-1

NOTES:

- *1 If dimension "L" is under 24 inches, the extender must not be used (see Figure 1 and 2). This applies to front lap seat belts equipped in the following models:
 - **Cressida** – '89, '90, '91, & '92 model years
 - **Camry** – '89, '90, & '91 model years
 - **Corolla** – on and after April, 1990 production, '91, & '92 model years
 - **Corolla 4WD Wagon** – '93 model only
 - **Tercel** – '91, '92, '93 & '94 model years
 - **Paseo** – '92, '93 & '94 model year

- *2 This seat belt was supplied by TOKAI RIKA. Make sure that the I/D mark on the back of the seat belt buckle is the same as shown in fig. 3.

- *3 This seat belt was supplied by QSS. Make sure that the I/D mark on the back of the seat belt buckle is the same as shown in fig. 4.

- *4 Extender must not be used for center seat belt on T100 & Truck equipped with bench seat.

- *5 R-3 must be used for Land Cruiser (FJ80) produced on and after January, 1990.



Figure 3



Figure 4

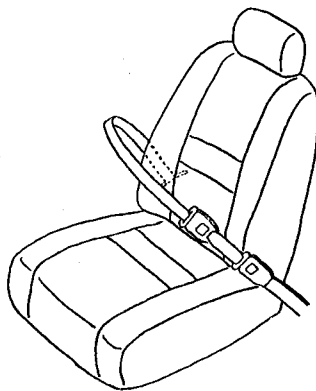

Figure 1

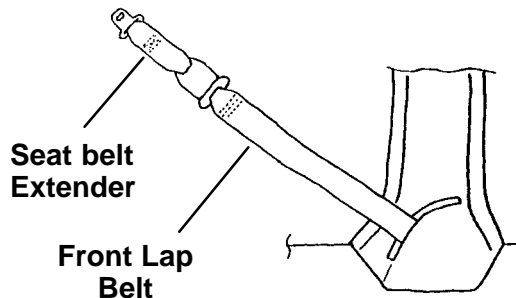

Figure 2

Note: The front lap belt for all '90 Corolla models and the '90 Tercel is the ALR type. Make sure the ALR is locked when the extender is used.

REAR SEAT – EXTENDER APPLICATION TABLE

MODEL	TYPE	'94	'93	'92	'91	'90	'89	'88	'87	'86	'85
Cressida	USA Spec.			K-2	K-2	K-2	K-2	K-1	K-1	K-1	K-1
Supra		R-3	R-3	N-4	N-4	N-1	N-1	N-2*1	N-2*1	N-2*1	N-1
Celica	L/B & Coupe	N-3	N-3	N-3	N-4						
	Convertible RH LH		N-1 N-5	N-1 N-5	N-1 N-5	N-1 N-5	N-1				
Camry	TMC	R-3	R-3	R-4	R-1	R-1	R-1	R-1	R-2	R-2	R-2
	TMM SDN	Q-2	Q-2	Q-3	Q-1	Q-1	Q-1				
	WGN	Q-2	Q-2	Q-2	Q-1	Q-1	Q-1				
	Coupe	Q-2									
Corolla (2 dr)	Sedan & H/T										
	Coupe				K-1	K-1	K-1	K-1	K-1	K-1	K-1
	Liftback								K-1	K-1	K-1
	FX							A*	A*		
Corolla (4 dr)	Sedan	R-3*2	R-3*2	R-1*1	R-1*1	R-1*1	R-1	R-2	R-1	R-1	R-1
	Wagon		R-3	R-3	R-1	R-1	R-1	R-2			
	4WD Sdn.			R-1*1	R-1*1	R-1*1	R-1				
	4WD Wgn.			N-1	N-1	N-1	N-1	N-2*1			
	TMMC Prd.	Q-2*3	Q-2*3	Q-1	Q-1	Q-1	Q-1				
	NUMMI Prd.	A-2	A-2	A-1	A-1	A-1	A-1*				
Tercel	2,3,5 dr Sdn					R-1	R-1	R-1	R-1	R-1	R-1
	2 & 4 dr Sdn	R-3	R-3	R-4	R-4						
	Wagon							R-1	R-1	R-1	R-1
	4WD Wgn							N-1	N-1	N-1	N-1
Paseo		R-3	R-3	R-4							

REAR SEAT – EXTENDER APPLICATION TABLE (CONT'D)

MODEL	TYPE	'94	'93	'92	'91	'90	'89	'88	'87	'86	'85
Truck (TMC Prod.)	Xtracab	R-1	R-1	R-1	R-1	R-1	R-1	R-1			
Truck (NUMMI Prod.)	Xtracab	R-1	R-1								
4 Runner	2/4-dr	R-1	R-1	R-1	R-1	R-1	R-1	K-1	K-1	K-1	K-1
Van/Previa		R-3	R-3	R-3	R-3	R-1	R-1	R-1	R-1	R-1	R-1
Land Cruiser	All	K-4	K-4	K-2	K-2	K-1* ⁴	K-1	K-1	K-1	K-1	K-1

NOTES:

- * For September and October, 1988 NUMMI Corolla production, the extender “R-1” must be used, not “A”.
- *1 For TMC production Corolla Sedan (on and after April, 1990 production, '91, & '92 models), if dimension “L2” & “L1” is under 13 inches (see figure 3), the extender **must not** be used.
- *2 This seat belt was supplied by TOKAI RIKA. Make sure that the I/D mark on the back of the seat belt buckle is the same as shown in fig. 4.
- *3 This seat belt was supplied by QSS. Make sure that the I/D mark on the back of the seat belt buckle is the same as shown in fig. 5.
- *4 For Land Cruiser (FJ80) production after January, 1990, extender “K-2” must be used.
- *5 If a vehicle is equipped with a rear 3-point seat belt, the extender “N-1” must be used, not “N-2”.

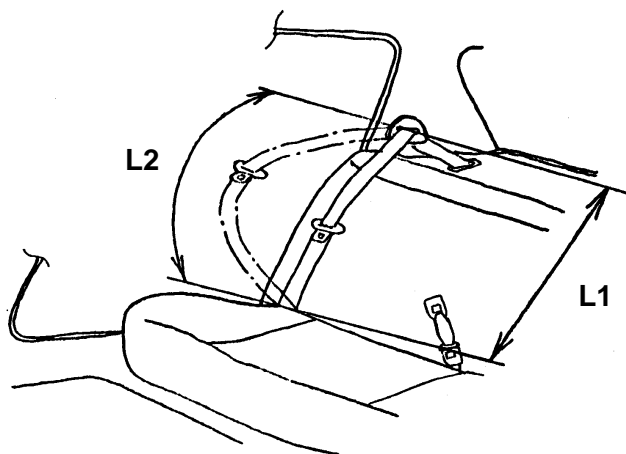

Figure 3



Figure 4



Figure 5

Note: The extender **must not be used** for the center rear seat belt on any model.

PART NUMBER INFORMATION:

(73399-_____)

Series	Length				
	6"	9"	12"	15"	18"
R-1	-12010	-12020	-12030	-12040	-12050
R-2	-12160	-12170	-12180	-12190	-12200
R-3	-50010	-50020	-50030	-50040	-50050
R-4	-16010	-16020	-16030	-16040	-16050
N-1	-12060	-12070	-12080	-12090	-12100
N-2	-12210	-12220	-12230	-12240	-12250
N-3	-20010	-20020	-20030	-20040	-20050
N-4	-20060	-20070	-20080	-20090	-20100
N-5	-20110	-20120	-20130	-20140	-20150
K-1	-12110	-12120	-12130	-12140	-12150
K-2	-22010	-22020	-22030	-22040	-22050
K-3	-22060	-22070	-22080	-22090	-22100
K-4	-33050	-33040	-33030	-33020	-33010
A-1	-02010	-02020	-02030	-02040	-02050
A-2	-01060	-01070	-01080	-01090	-01100
Q-1	-02060-B1	-02070-B1	-02080-B1	-02090-B1	-02100-B1
Q-2	-06010	-06020	-06030	-06040	-06050
Q-3	-06060	-06070	-06080	-06090	-06100

OWNER INSTRUCTION:

Failure to follow the recommendation indicated below could result in less effectiveness of the seat belt restraint system in case of vehicle collision, causing personal injury.

1. The seat belt extender must not be used:
 - (I) By anyone other than for whom it was provided (name recorded on seat belt extender).
 - (II) In any vehicle or seat position other than the one for which it is provided.
2. To connect the extender to the seat belt, insert the tab into the seat belt buckle so that the buckle–release buttons of the extender and the seat belt are located on the same side as shown. You will hear a click when the tab locks into the buckle. Make sure that the connection is secure and the seat belt extender is not twisted.
3. When the seat belt extender is provided for rear seat position (with automatic locking retractor), make sure the retractor is locked when in use.
4. When releasing the seat belt, press on the buckle–release button on the extender, not on the seat belt. This helps prevent damage to the vehicle interior and extender itself.

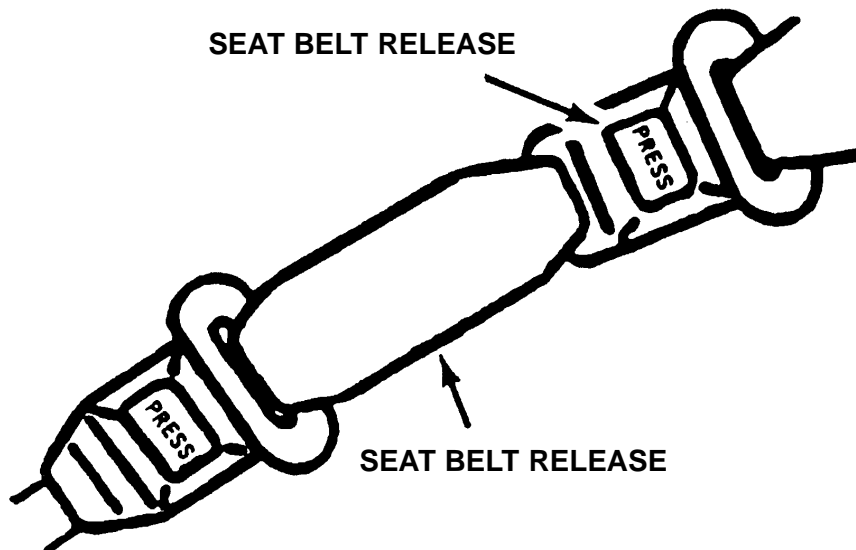

5. When not in use, remove the extender and store in the vehicle for future use.

OWNER'S MANUAL TEXT:**Seat belt extender**

If your seat belt cannot be fastened securely because it is not long enough, a personalized seat belt extender is available from your Toyota dealer free of charge.

Please contact your local Toyota dealer so that the dealer can order the proper required length for the extender. Bring the heaviest coat you expect to wear for proper measurement and selection of length. Additional ordering information is available at your Toyota dealer.

CAUTION:

When using the seat belt extender, observe the following. Failure to follow these instructions could result in less effectiveness of the seat belt restraint system in case of vehicle accident, increasing the chance of personal injury.

- **Never use the seat belt extender if you can fasten the seat belt without it.**
- **Remember that the extender provided for you may not be safe when used on a different vehicle, or for another person and at different seating positions than specified.**

To connect the extender to the seat belt, insert the tab into the seat belt buckle so that the buckle-release buttons of the extender and the seat belt are located on the same side as shown.

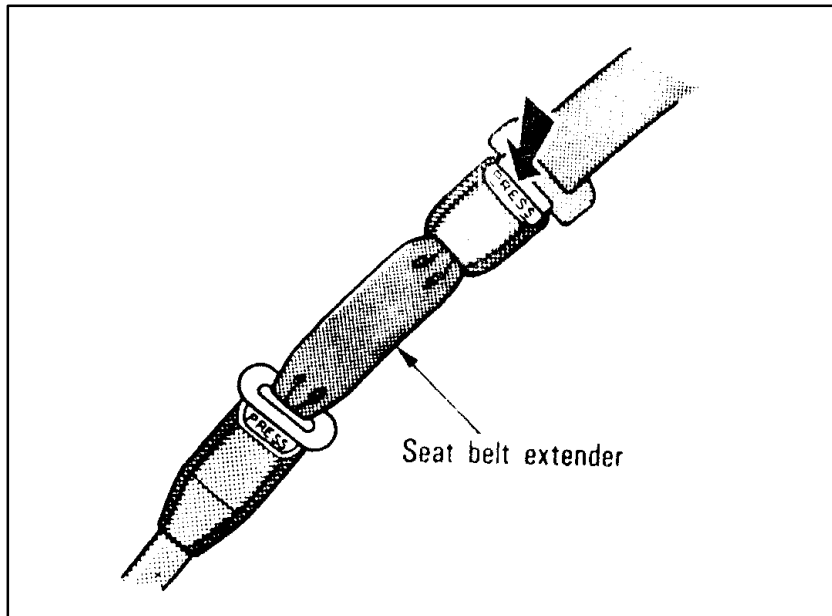

You will hear a click when the tab locks into the buckle.

When releasing the seat belt, press on the buckle-release button on the extender, not on the seat belt. This helps prevent damage to the vehicle interior and extender itself.

When not in use, remove the extender and store in the vehicle for future use.



APPLICATION FOR SEAT BELT EXTENDER

5082

(Only one extender can be processed per application form)

In order to provide a personalized extender for the seat belt, all of the following specific information must be provided regarding the individual and vehicle involved.

CAUTION: To minimize the chance and/or severity of injury in an accident, the seat belt extender **must not be used:**

- By anyone but the person for whom it was provided, and
- In any vehicle or seat specified other than the one for which it was provided.
- With any car seats for children.

When the seat belt extender is provided for rear seat position (with automatic locking retractor), make sure the retractor is locked when in use.

IMPORTANT: Application must be complete for processing.

DEALER		PLEASE PRINT CLEARLY				APPLICANT	
DEALER CODE 82430	DEALER NAME TOYOTA DEALER USA	NAME JOE CUSTOMER					
ADDRESS 12 AUTO CENTER DRIVE		ADDRESS 8 MAIN ST.					
CITY AND STATE TOYOTA CITY CA		ZIP CODE 99999	CITY AND STATE ANYTOWN CA.		ZIP CODE 9999	TELEPHONE (310) 555-1212	
DEALER EMPLOYEE NAME J SMITH - PARTS MGR.		MODEL YEAR 1993	BODY TYPE PREVIA	SEAT POSITION Ⓢ / R	VEHICLE IDENTIFICATION NUMBER JT3AC12RXR5000000		
				MILEAGE 2,594	DOFU		

3 POINT SEAT BELT MEASUREMENT

1. Place the seat in the position the occupant normally uses.
2. With occupant in the seat, extend the seat belt as much as possible and see if the seat belt does or does not latch.
3. If seat belt does not latch, then measure the distance from seat belt latch edge to the seat belt buckle, as shown in Figure 2, and note the dimension.
4. Measure the lap area directly below navel to the edge of the buckle, as shown in Figure 1 below, and note the dimension.
5. The difference between Figure 1 and Figure 2 measurement is the Allowable Margin. The customer relations department will determine the extender length.

Dimension from navel to buckle

FIG. 1

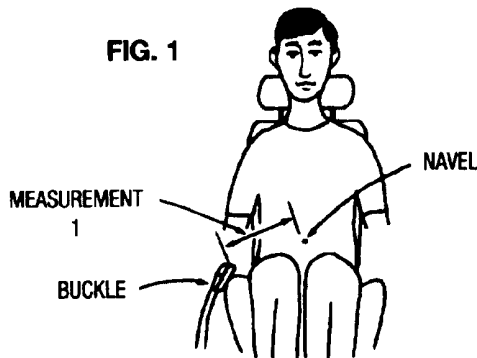

Dimension from latch to buckle

FIG. 2

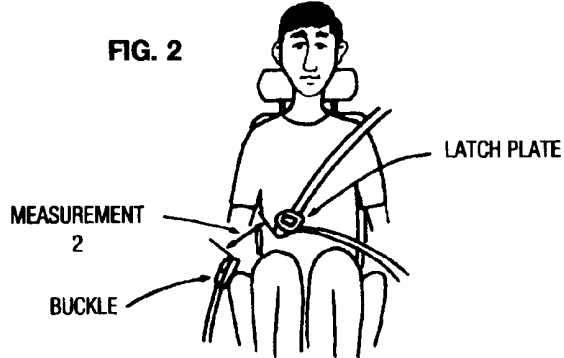

MEASUREMENT 1 (Figure 1) – MEASUREMENT 2 (Figure 2) = Allowable Margin

20" – 6" = 14"

FOR TMS USE ONLY	
EXTENDED LENGTH REQ.	PART NUMBER
LEAVE BLANK	73399 - LEAVE BLANK

NOTE: If the Allowable Margin is smaller than 6 inches, the seat belt extender will not be available due to design and construction features.

AUTHORIZATION

The same extender may be used for right and left seating applications. Each seat belt extender will be affixed with a label identifying the owner, vehicle VIN and seating position. The extender will be available only in one color. Send completed form to TMS Customer Relations - A102.

MUST HAVE CUSTOMER SIGN TO BE PROCESSED

APPLICANT'S SIGNATURE
(actual user of the seat belt extender)

DATE

16